

Within the following pages are diagrams, plans, testimonials, my statement and an advertisement for my products. I create two models of light weight tarp tents. The Duo is the two person model and the Loner is the one person model. Both of these are available with or without no-see-um bug mesh. Detailed information about both of these products can be found in the following pages.

I also sew tarps, water carriers, backpacks and could possibly create many other special order items. These tarp tents would be great for program use and can be created with heavier fabric to better fit program needs.

Have a nice journey through the information that follows.

Ben Yandeau

ben_yandeau@yahoo.com

Intro/contents	1
Statement	2
Materials	3
Loner demensions	4
Loner materials list	5
Loner no mesh materials list	6
Duo demensions	7
Duo materials list	8
Duo no mesh materials list	9
Testimonial Joel	10
Testimonial Meg	11
Advertisement	12



My Statement



While carrying a heavy pack on many backpacking trips in the Adirondack's and Catskill's I realized how my tent had many extras that weren't necessary. There were poles, a fly, and lots of pockets. All of these were just heavy and unnecessary.

During this same time I was experimenting with using tarps. The downfall here was with bugs. I became a fast-food restaurant for those blood thirsty flying syringes. I decided to combine the bug proof features of a tent with the minimalist structure of the tarp. To do this I researched many designs and developed one that would meet my needs. With sewing lessons from my mom, cutting skills of my dad, and my own interest we created my first tent.

While this tent was not the prettiest, it has completed a thru hike of the Appalachian Trail, gone on a bicycle tour from Maine – Oregon – Salt Lake City Utah, and has traveled many weeks at a time while being a field instructor at Adirondack Leadership Expeditions in New York's Adirondacks. Four years after it's creation I still use it.

Tarp tents have been around long before I designed mine. Like the Cliff Bar, I feel that I have refined many other designs to create one that works well for me and many others. I make these tents to help others enjoy the simplicity of traveling.

Ben Yandeau

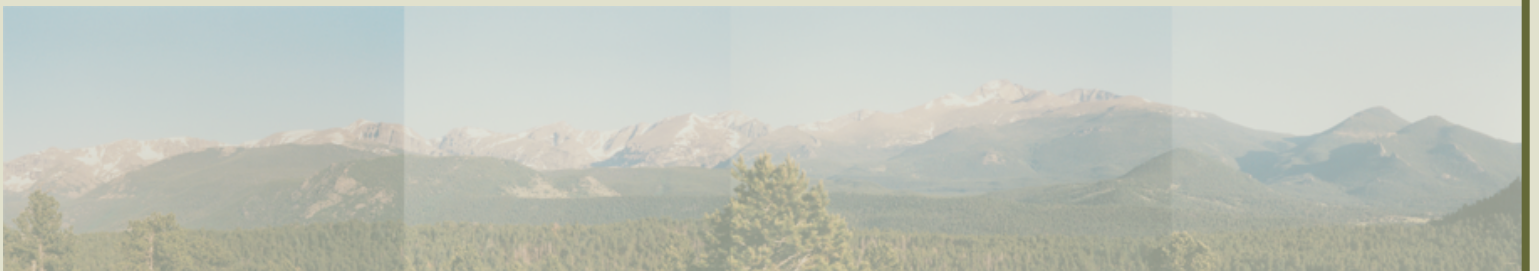

Loner and Duo Mesh Materials Diagrams

3

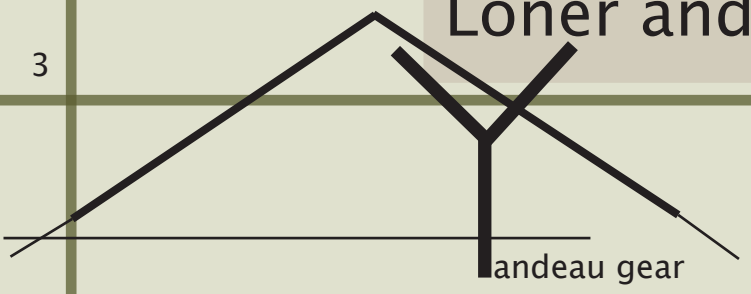

Lander gear

Top View

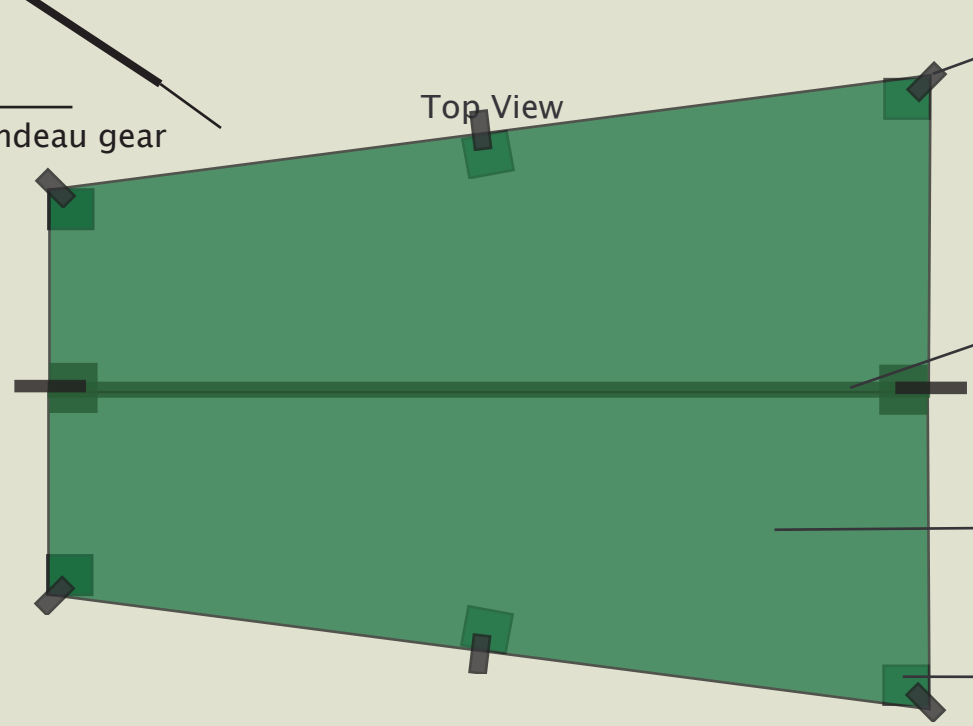

1/2 inch Webbing Tie Outs x8

Ridgeline Seam

1.1 oz Silicone Impregnated Nylon

Reinforced Tie Out Patches

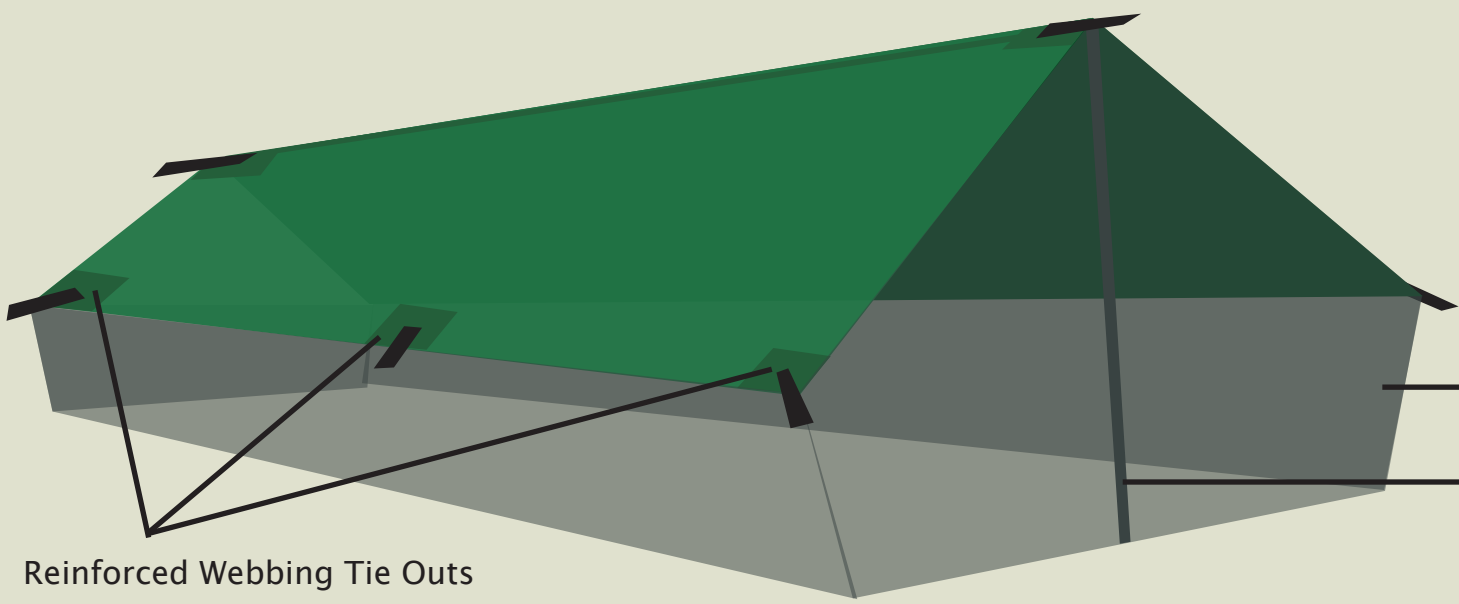

No-see-um Bug Mesh

#5 zipper

Reinforced Webbing Tie Outs

Loner Mesh Dimensions

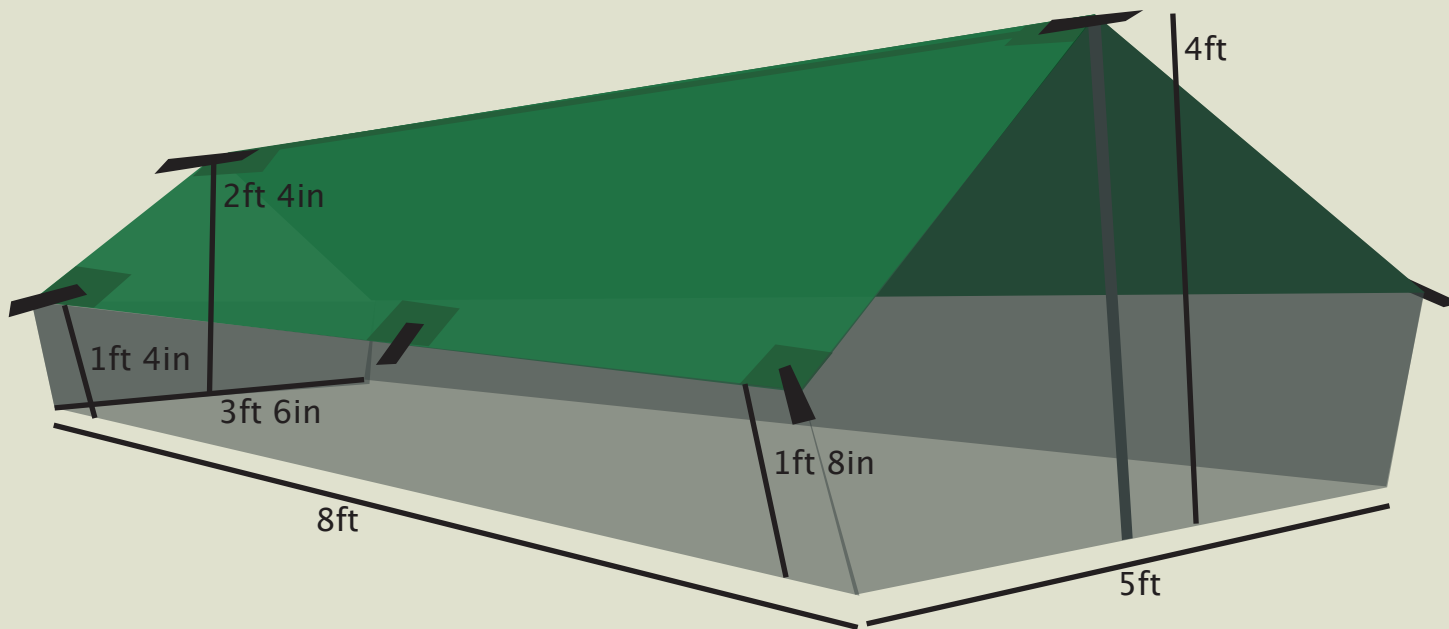
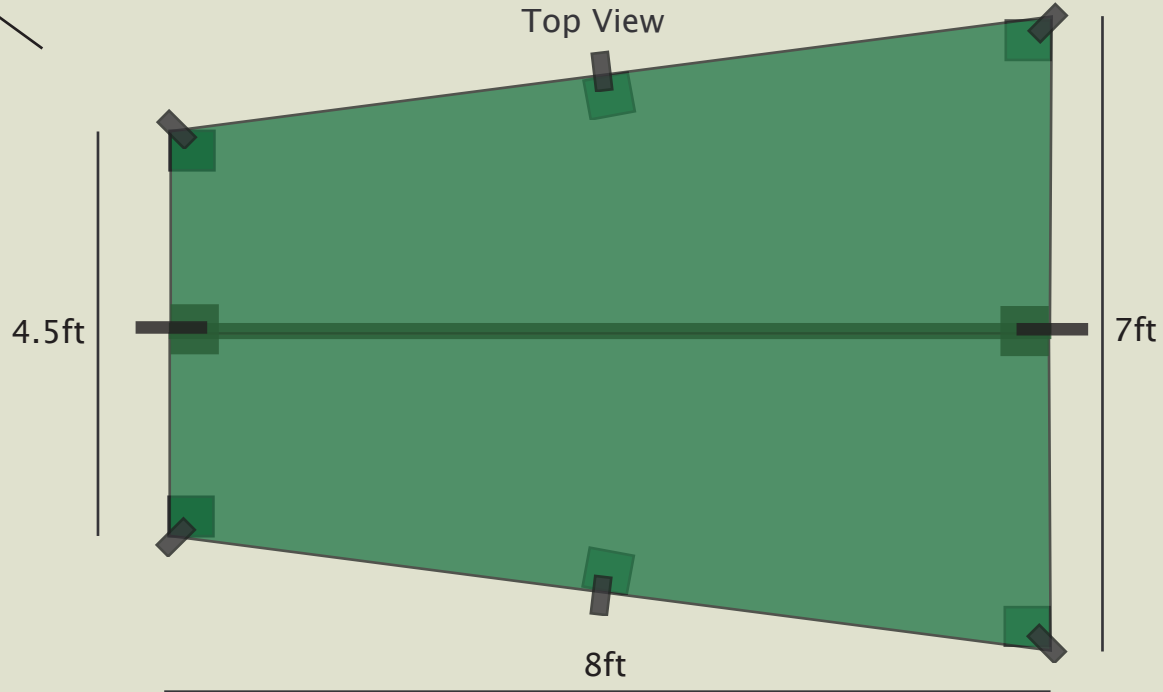
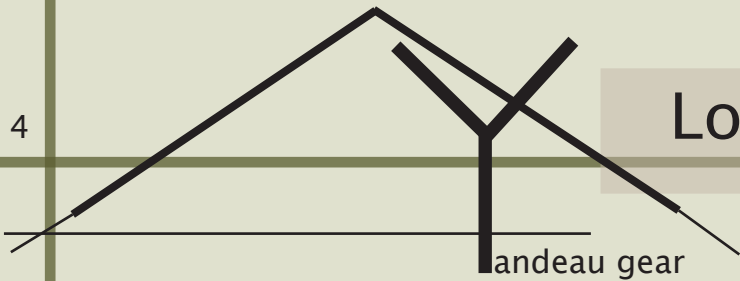

1 Person Tent Materials Cost List

"The Loner"

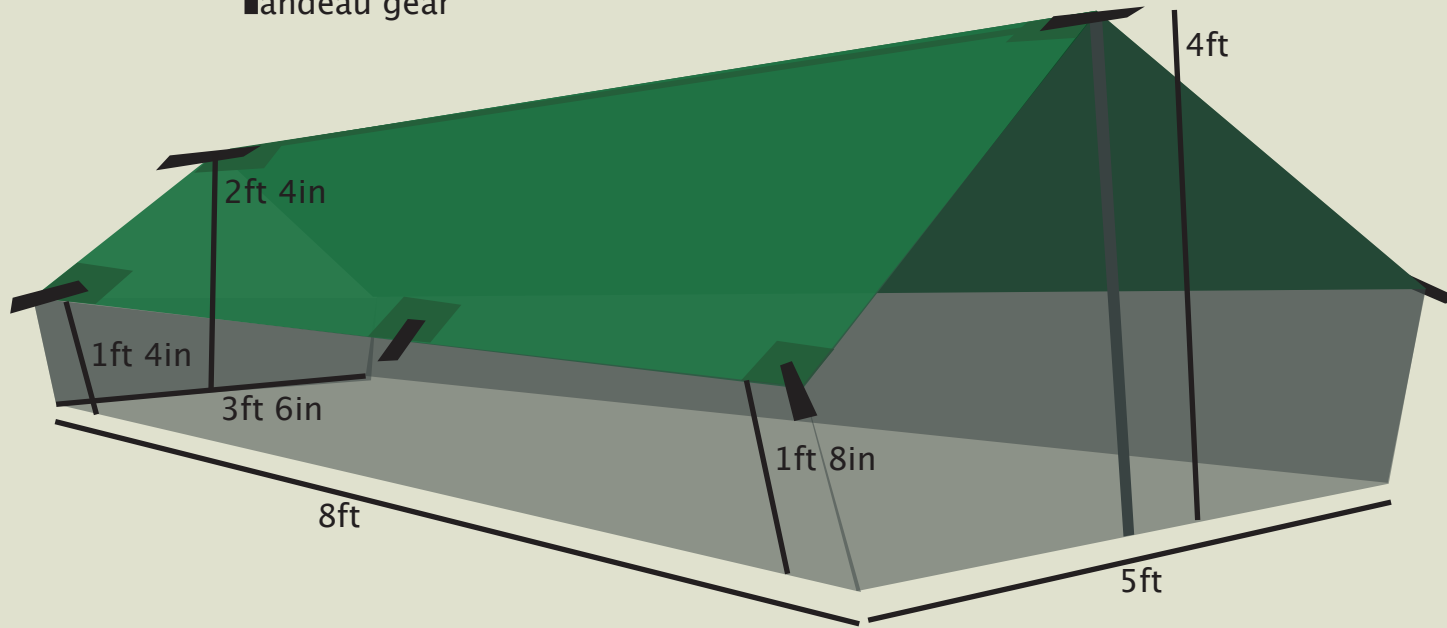
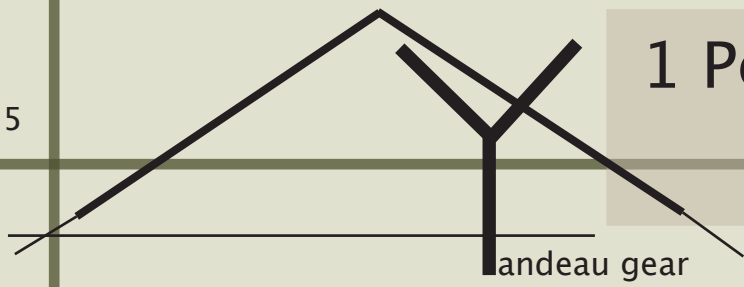

fabric	cost	amount needed per tent	itemized cost per tent
1.1 oz silicone impregnated nylon	4.00 per yard	3.5 yards	14.00
1/2 flat webbing	.35 per foot	3.5 feet	1.23
no-see-um bug mesh	2.25 per yard	5 yards	11.25
#5 zipper	.17 per foot	4 feet	.68
#5 sliders	.20 per slider	1 slider	.20
#5 bottom stops	.05 per stop	2 stops	.10
p-cord	4.50	50 feet	4.50
thread poly gutermann 403	3.50 spool		1.00
			total per tent: 32.96
labor	15.00 hr	8 hr	total price: 150.00

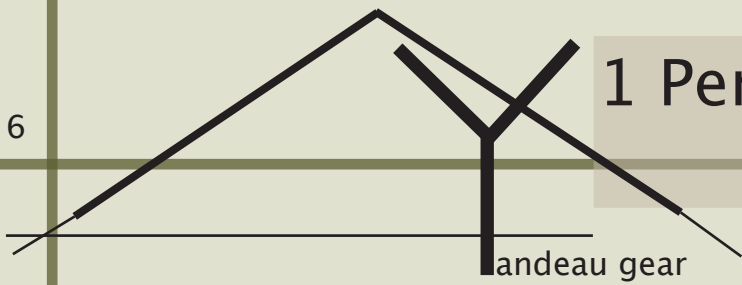

1 Person Tent Materials Cost List "The Loner"

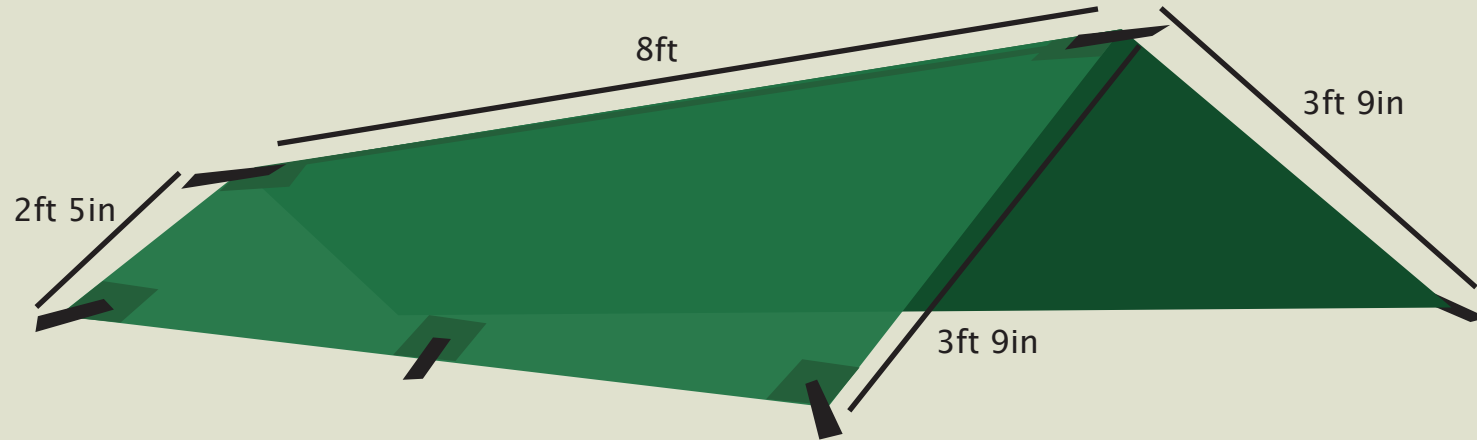

fabric	cost	amount needed per tent	itemized cost per tent
1.1 oz silicone impregnated nylon	4.00 per yard	3.5 yards	14.00
1/2 flat webbing	.35 per foot	3.5 feet	1.23
p-cord	4.50	50 feet	4.50
thread poly gutermann 403	3.50 spool		1.00
			total per tent: 20.73
labor	15.00 hr	4 hr	total price: 80.00

Duo Mesh Dimensions

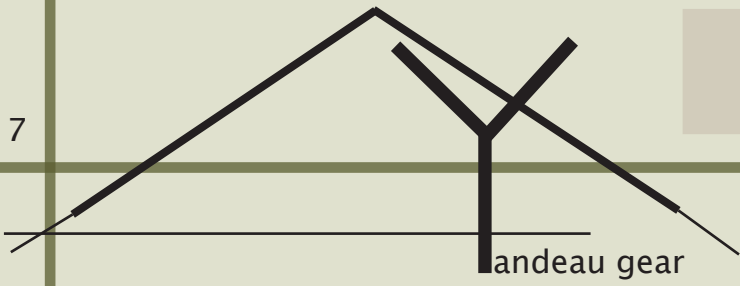

7

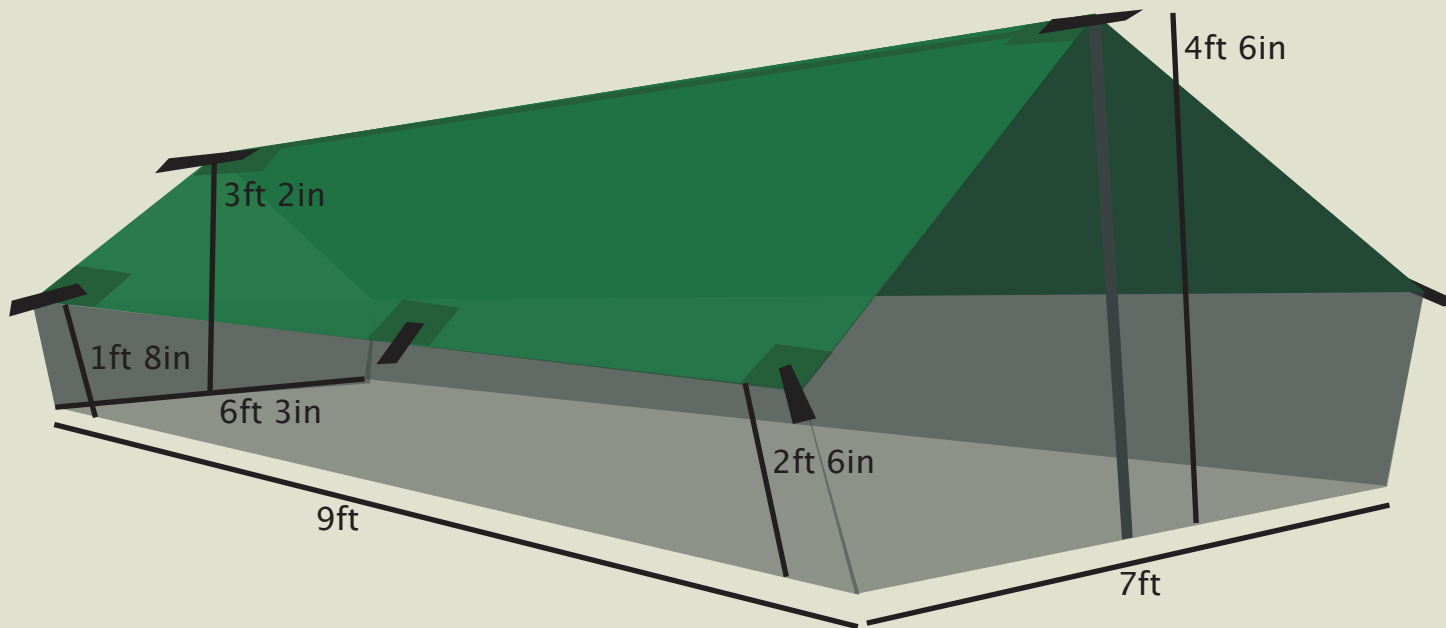
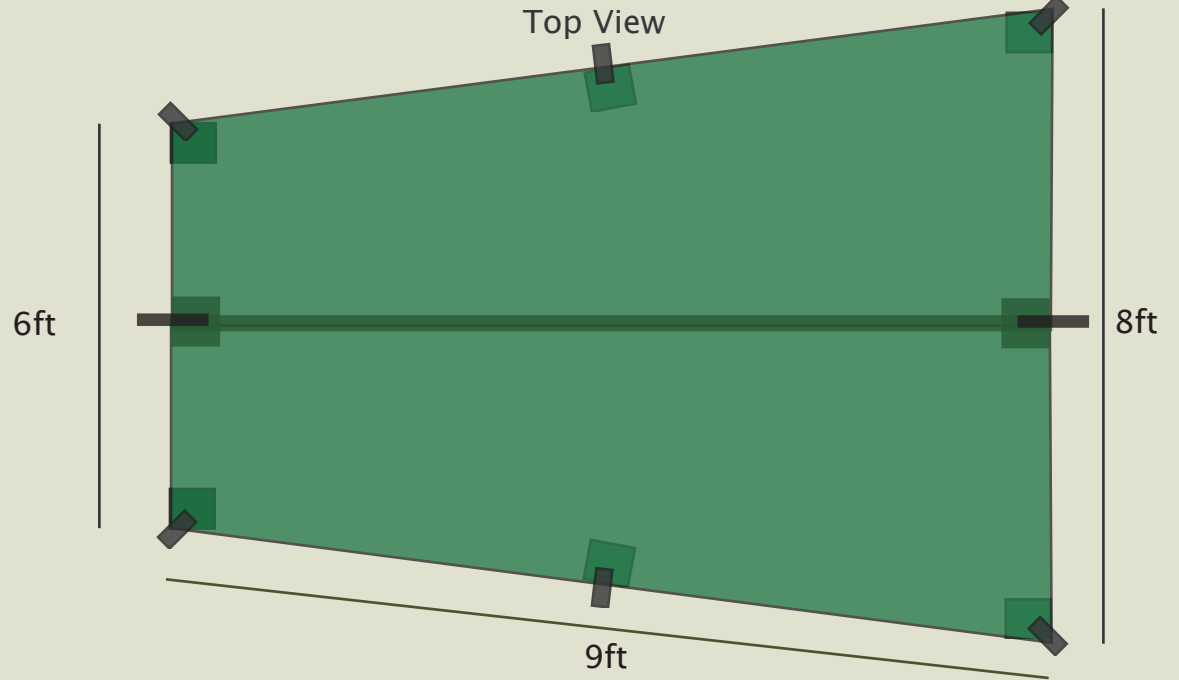

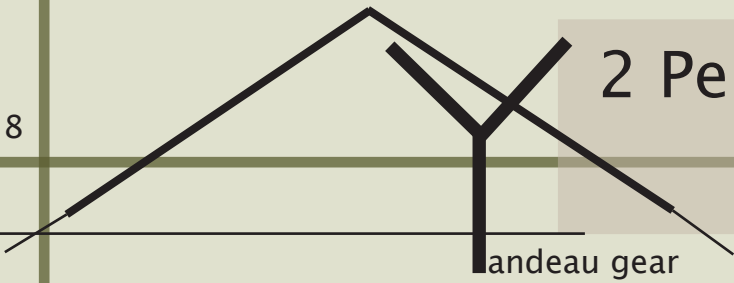

2 Person Tent Materials Cost List "The Duo Mesh"

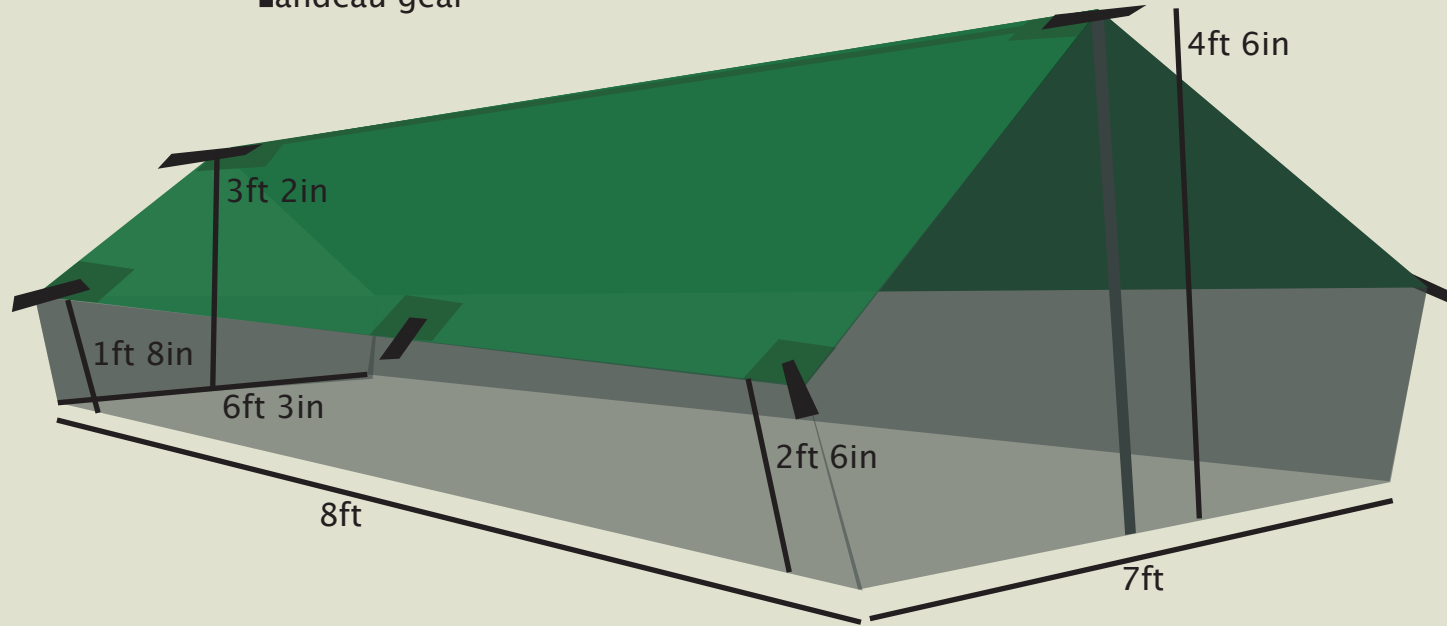

fabric	cost	amount needed per tent	itemized cost per tent
1.1 oz silicone impregnated nylon	4.00 per yard	5.5 yards	22.00
1/2 flat webbing	.35 per foot	3.5 feet	1.23
no-see-um bug mesh	2.25 per yard	7 yards	15.75
#5 zipper	.17 per foot	4.5 feet	.85
#5 sliders	.20 per slider	1 slider	.20
#5 bottom stops	.05 per stop	2 stops	.10
p-cord	4.50	50 feet	4.50
thread poly gutermann 403	3.50 spool		1.00
			total per tent: 45.63
labor	15.00 hr	9 hr	total price: 180.00

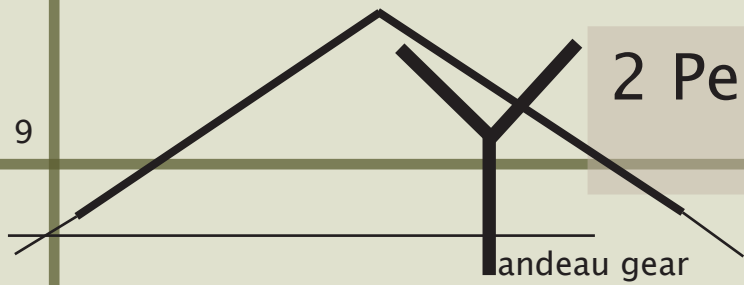

2 Person Tent Materials Cost List "The Duo"

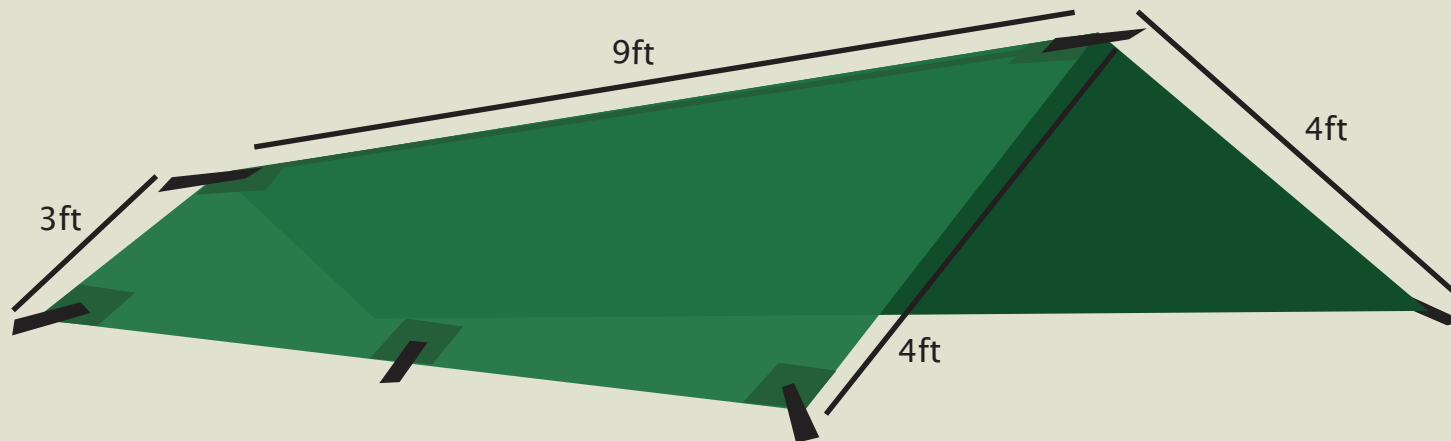

fabric	cost	amount needed per tent	itemized cost per tent
1.1 oz silicone impregnated nylon	4.00 per yard	5.5 yards	22.00
1/2 flat webbing	.35 per foot	3.5 feet	1.23
p-cord	4.50	50 feet	4.50
thread poly gutermann 403	3.50 spool		1.00
			total per tent: 28.73
labor	15.00 hr	4 hr	total price: 90.00

Testimonials

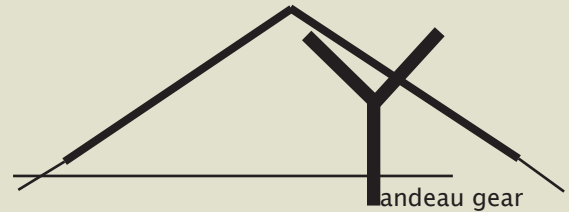

Joel Brandt

- Appalachian Trail Thru Hiker
- Completed a cross country bike tour from Maine – Oregon – Salt Lake City Utah
- Adirondack 46er
- Field instructor for Adirondack Leadership Expeditions

Someone started a myth that in order to enjoy the wilderness you need the latest in top of the line extreme gear. This is about as pointless as the rational that convinces most people to buy SUV's thinking that they are going to use it to off-road through mountain passes, transport their surfboards climbing gear and skis to solitary outdoor Mecca's, or race cheetahs across the Savannah-it never happens. Needless to say SUV's spend more time stuck in traffic, making soccer mom's look hot, and burn ridiculous amounts of gas than the marketing dream they were bred for.

Ben's tent is the outdoor persons' alternative to the sucker punch of outdoor marketing (take that North Face). Although sometimes a hardcore tent is needed it definitely has its time and place. I would care to venture the challenge that my tarp tent (from Ben) has been more places and experienced more extreme conditions than most 4-seasons tents could shake a stick at (and performed as good if not better).

To start Ben's tent weights a fraction of the weight of other tents as well as compact's better-a must for anyone who wants to save pack weight. I have used the tent from the downpours of the Oregon coast to the black fly season of the Adirondacks and literally everywhere in between (I took the tent on a cross country bike trip for three months). The tent always performs like a champ-keeps the rain and bugs out, and leaves me comfortable and protected. Instead of loathing the weight every time I pack up as I would a bulky tent, I barely notice the space it occupies in my panniers or backpack, but its comfort and protection are amazingly un-proportionate to its size making it unquestionably an item that comes with me every time I travel outdoors for the night.

Ben has perfected the simplicity of shelter eliminating the unnecessary bells and whistles all owing the owner to experience the wilderness as it should be -a simple, beautiful, and pleasurable way to adventure.

Joel Brandt

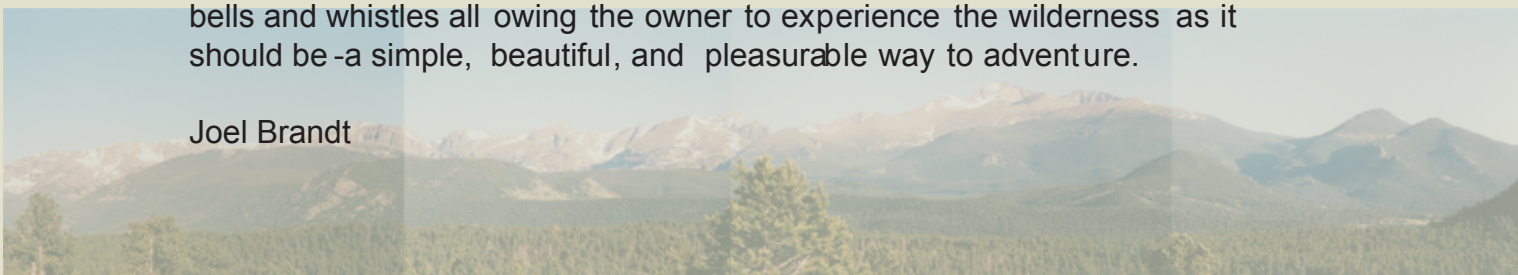

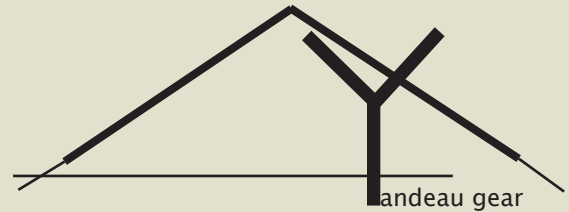

Meg Mack

- St. Lawrence University Outdoor Program Guide
- Member of University Outing Club
- Northville – Placid Trail Thru Hiker

This is a five star out of four star tent. The previous tent I used was a Mountain Hardwear tent that was really nice, but it just doesn't compare to the experience of a loner tent. Well, what can I say, it's simple. As a small person I love that I don't have to carry all the weight of a typical tent. I found the set up process to be much faster. It does exactly what a tent is required to do. I was bug free, and dry on my trip along the Northville-Placid Trail. All of my gear fit in the tent, and I still had extra room. Did I mention the tent looks cool?

The tent is made locally in Potsdam N.Y. by an avid backpacker/traveler that has designed the tent to satisfy the minimalists needs. Ben is not about making money he is about getting people outside. He likes to get people outside by making simple tents that do not have extra gadgets that break.

It is nice to support someone who does this as a hobby and still understands what it is like to be outside in the woods. It is great to know that he uses his equipment as much if not more than the people that he makes it for. It is hard to think of that when purchasing a product from a major corporation.

Meg Mack

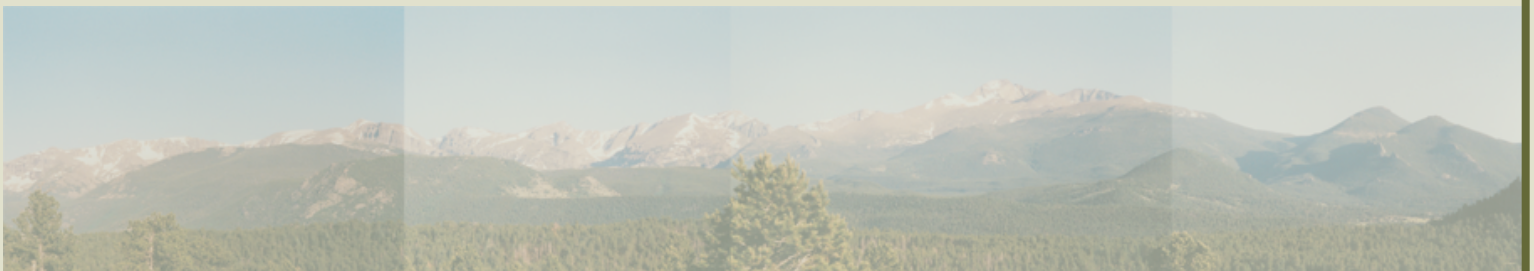

12

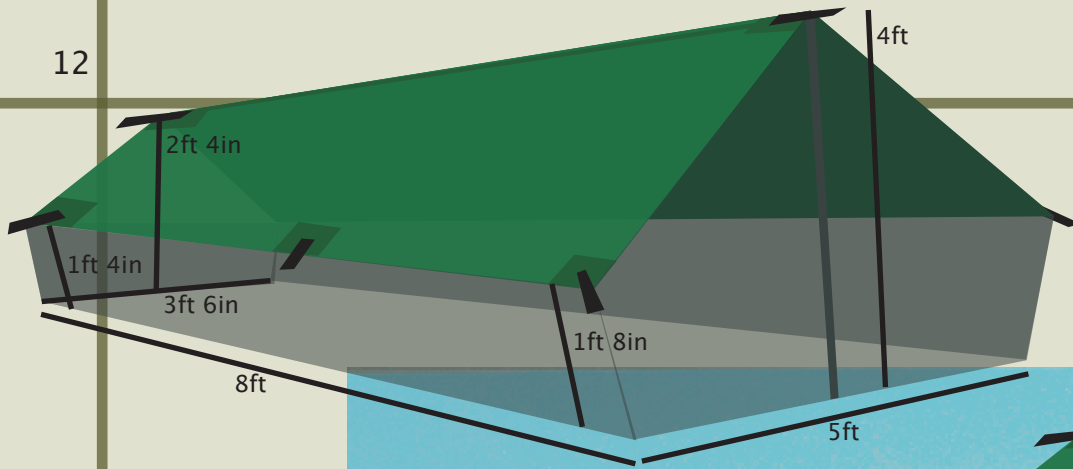

Loner 150.00

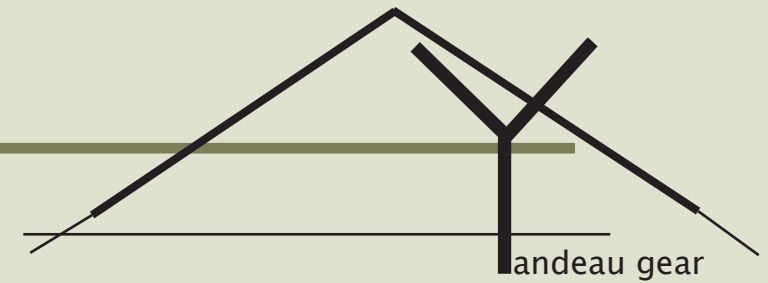

Yandeau gear

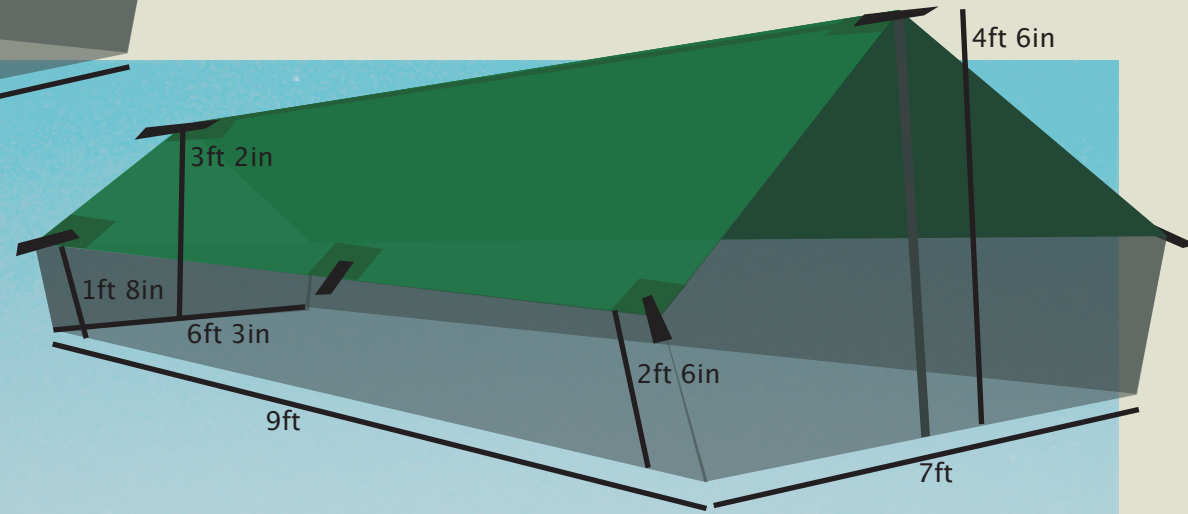

Duo 180.00

Materials:

- 1.1oz silicone impregnated nylon
- .5 in nylon webbing pull outs
- reinforced pull outs
- no-see-um bug mesh
- front door has a zipper
- p-cord for pull outs

Not included:

- tent stakes
- a choice of color
- floor (use plastic or tyvek ground cloth)
- poles (use trees, trekking poles, your dog)
- useless pockets and gadgets that are never used

Loner and Duo Tents by Yandeau gear

Tarp tents have been around long before I designed mine. Like the Cliff Bar, I feel that I have refined many other designs to create one that works well for me and many others. I make these tents to help others enjoy the simplicity of traveling.